

i-SPEED SERIES



i-SPEED® 7 SERIES

Premier high-speed cameras for the most demanding applications.



THE FASTEST JUST GOT FASTER

3.2 MEGAPIXEL CMOS SENSOR

2.45 MILLION FPS MAX SPEED

27+GPIXELS/S

2072 x 1536 @ 8,512FPS

1920 x 1080 @ 12,742FPS

ISO 16,000 / 125,000

SYNCHRONIZED INTEGRATED
LIGHTING CONTROL*

ELECTROMECHANICAL SHUTTER

DIRECT CONNECT REAR PANEL

UP TO 2TB EXTERNAL SSD

2TB INTERNAL SSD

NEW RUGGED HIGH G RATED
BODY DESIGN

HANDHELD CONTROL
DISPLAY UNIT

REMOVABLE HANDLE

MODEL UPGRADE
PROGRAM

MADE IN THE UK AND USA



**Patent pending*

The newest AST CMOS ultra-high speed sensor

The heart of a high-speed camera is the sensor. The i-SPEED® 7 Series is no different. Employing our newest Advanced Sensor Technology (AST), the sensor in our newest i-SPEED 717, 721, and 727 cameras is the most advanced, highest performing sensor in the iX Cameras line of products.

iX Cameras designs and develops its own state-of-the-art proprietary sensors. This commitment to excellence and quality control keeps us ahead of the commercial sensors found in most high-speed cameras. In 2018, we launched our AST initiative. The first sensor of this endeavor was the 1920 x 1080 HD sensor utilized in the i-SPEED 5 Series. The new 2072 x 1536 3.2 MPixel AST sensor builds upon that success.

The newest AST CMOS sensors boast increased light sensitivity, enhanced image clarity, ultra-high-resolution at high speeds that reach 2.45 million frames/second, and proprietary black level control for deeper blacks and low noise.

Spectral response curves

Our latest custom designed CMOS sensor with class leading light sensitivity provides high quality images for accurate analysis.

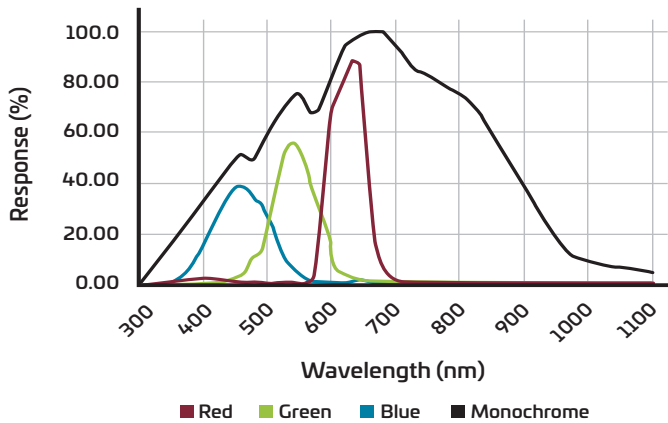

The 27.1 GPixels/s raw throughput rate is the fastest in the industry. No spatial or temporal interpolation. Raw speed, the 168ns shutter time is also among the fastest. We even optimized the 13.5 μm pixel size for the proper balance between high-resolution (for image clarity) and exceptional light sensitivity normally found only with larger pixels.

Sensor highlights

- 3.2 Megapixel CMOS Sensor
- Optimized full well capacity
- Full 12 bit dynamic range
- Dynamic pixel control
- New sensor drive engine
- 27.1 GPixels/s throughput
- Exceptional light sensitivity
- 13.5 μm pixel size

Features that redefine high-speed performance

Unparalleled throughput

The i-SPEED® 7 Series (717, 721, and 727) provides an increased 2072 x 1536 resolution that raises throughput speeds to 27.1 GPixels/second (27.1 billion pixels processed every second)—at even higher frame speeds. The balance between resolution and frame rate produces amazingly clear images at impressive resolutions that are critical for accurate motion analysis.

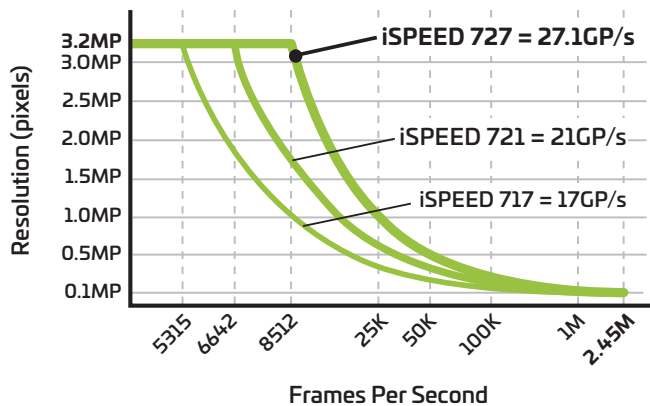

Electromechanical shutter

Continuing our tradition of developing easy-to-use cameras, we added an optional electromechanical shutter to the new i-SPEED 7 Series. This new feature enables remote reference, automated calibration, and sensor protection during lens changes. The

electromechanical shutter makes the new i-SPEED 7 Series ideal for field work where the camera is at a distance from the user and for DIC and PIV applications where the camera must not be moved after a calibration frame.



Synchronized Integrated Lighting Control (SLC)*

The new integrated lighting control allows users to accurately control external lighting independent of the camera's exposure duration. Three modes allow the user to set up a single pulse per frame, double pulse per frame, or change pulse duration on alternating frames. This feature is ideal for LED and PIV laser illumination where the timing of the light in relation to the exposure can be tightly controlled. Delay, duration, and relative position for each pulse can be defined, allowing for superior lighting control and advanced camera synchronization possibilities.



*Patent pending

Direct connect rear panel

The newly designed rear panel of the i-SPEED 7 Series added more BNC connections to reduce the requirement for a feature lead. Now the Trigger, Sync In/Out and Exposure Out are on the rear panel. Exposure Out can be switched to synchronized lightning control.

- | | |
|--|--|
| 1 Power Input 12-36V | 5 Power button |
| 2 HD-SDI / HDMI video output | 6 Trigger input BNC |
| 3 1Gigabit Ethernet control and download | 7 Sync In/Out BNC |
| 4 Optional Internal batteries | 8 Exposure Out BNC |
| | 9 I/O connector
12V Out
IRIG in
Trigger
GPIO |

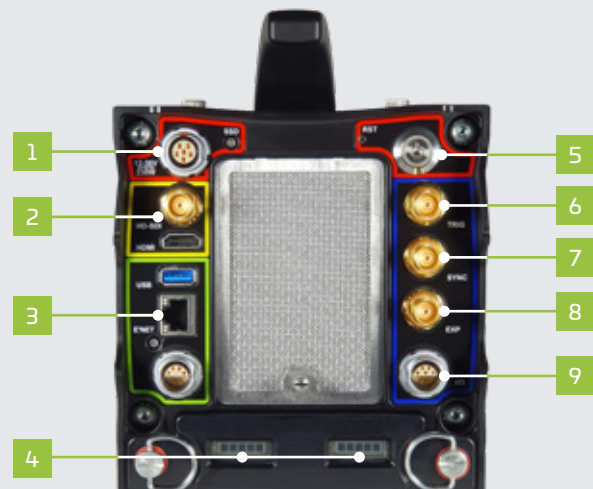

Rugged high-G rated body design

iX Cameras engineers combined the i-SPEED® 7 Series instrumentation and rugged models into one innovative camera housing ideal for both laboratory and challenging field environments. The sturdy rugged design features a high-G rated two-piece aluminum enclosure for exceptional protection. The redesigned all aluminum enclosure also includes a user removable handle to provide greater flexibility when mounting the camera to a static frame. Removing the handle exposes fixing points to facilitate the connection of other components such as the CDUe or lights, displays, booms, etc.



2TB internal SSD storage

Recording at high speeds with high resolutions produces a great deal of data. The i-SPEED 7 Series camera can be configured with up to 2TB of internal SSD storage. You can quickly and seamlessly transfer data from the camera's internal RAM memory to secure, non-volatile SSD—without touching the camera—for subsequent analysis. A 2TB capacity allows the user to store multiple recordings and conduct tests in quick succession.

Don't stop—just swap

Swappable SSD technology allows you to transfer high resolution images between a camera and a computer. The external solid state drive (xSSD) memory cartridge, available in 250GB, 500GB, 1TB, and 2TB sizes, is ideal for secure non-volatile storage of large video files without interrupting the video capture process.



Revolutionary CDUe for complete camera control

The industry unique CDUe (Controller Display Unit) makes operating the camera quick, intuitive, and portable. The CDUe easily allows you to frame your field of view, set resolution, frame rate and shutter speed, record and review with the touch of a finger. Combine the CDUe with battery option for the camera and take your system to the field to run without the need of a laptop or power supply.



Unplug and go with internal batteries

The optional battery set adds to the portability of the i-SPEED 7 Series camera, providing a one-hour charge without external power that can be swapped with another set for extended use. Data security is essential when tests cannot be repeated or in environments where the threat of power loss exists. Ensure that your video will be secure and intact with internal batteries that engage as soon as external power is lost.

i-CHEQ status monitoring

Monitor your camera's status at a glance and in real-time with i-CHEQ 360. View in-camera details for single or multiple camera setups with Remote i-CHEQ, part of the i-SPEED Software Suite 2.0. Understand your camera's exact status using the three variable color lights on the front of the camera and mirrored inside the control software.



Real-time health monitor

Observe the camera's internal condition and external environment. Switch off fans (Quiet Mode) to prevent vibration in microscopic applications. View battery status (if present), voltage information, fan speed and camera temperature.

Battery	
AC Lead	Present
Battery	Present Present
Charging	Present Present
Charge	96% 97%
Voltage / Current	0.00 V / 0.00 A 0.00 V / 0.00 A
Cycles	0 0
Maximum Error	0 0
Calibration	Required Required
Time Rem. (min)	1:11 1:03

Performance

Upgrade path between three models

The i-SPEED® 7 Series has been designed to allow for easy upgrades between models as performance or application requirements increase. Add additional memory and options such as xSSD or upgrade to a higher performance model.

i-SPEED® 727

Frame Speed	Resolution	36GB	72GB	96GB	144GB	288GB
1,000	2072x1536	8.1	16.2	21.6	32.4	64.8
2,000	2072x1536	4.0	8.1	10.8	16.2	32.4
5,000	2072x1536	1.6	3.2	4.3	6.5	13.0
7,500	2072x1536	1.1	2.2	2.9	4.3	8.6
8,512	2072x1536	1.0	1.9	2.5	3.8	7.6
10,000	1920x1374	1.0	1.9	2.5	3.8	7.6
12,742	1920x1080	1.0	1.9	2.5	3.8	7.6
15,000	1568x1134	1.0	1.9	2.6	3.9	7.7
20,000	1344x960	1.0	2.0	2.7	4.0	8.0
30,000	1064x798	1.0	2.0	2.7	4.0	8.1
50,000	840x606	1.0	2.0	2.7	4.0	8.1
100,000	840x294	1.0	2.1	2.8	4.2	8.3
200,000	840x134	1.1	2.2	3.0	4.4	8.9
500,000	672x54	1.4	2.8	3.8	5.7	11.4
750,000	672x30	1.7	3.4	4.5	6.8	13.6
1,000,000	560x24	1.9	3.8	5.1	7.7	15.3
2,450,000	280x12	3.1	6.3	8.3	12.5	25.0

i-SPEED® 721

Frame Speed	Resolution	36GB	72GB	96GB	144GB	288GB
1,000	2072x1536	8.1	16.2	21.6	32.4	64.8
2,000	2072x1536	4.0	8.1	10.8	16.2	32.4
5,000	2072x1536	1.6	3.2	4.3	6.5	13.0
6,642	2072x1536	1.2	2.4	3.2	4.9	9.7
7,500	1960x1428	1.2	2.5	3.3	4.9	9.8
9,944	1920x1080	1.2	2.4	3.3	4.9	9.8
10,000	1680x1242	1.2	2.5	3.3	4.9	9.9
15,000	1344x1008	1.3	2.5	3.4	5.1	10.1
20,000	1176x864	1.3	2.5	3.4	5.1	10.1
30,000	952x696	1.3	2.6	3.5	5.2	10.4
50,000	840x462	1.3	2.7	3.5	5.3	10.6
100,000	840x216	1.4	2.8	3.8	5.7	11.4
200,000	840x96	1.6	3.2	4.3	6.4	12.8
500,000	672x42	1.8	3.7	4.9	7.3	14.6
750,000	448x36	2.1	4.3	5.7	8.5	17.0
1,000,000	448x24	2.4	4.8	6.4	9.6	19.2
2,450,000	280x12	3.1	6.3	8.3	12.5	25.0

i-SPEED® 717

Frame Speed	Resolution	36GB	72GB	96GB	144GB	288GB
1,000	2072x1536	8.1	16.2	21.6	32.4	64.8
2,000	2072x1536	4.0	8.1	10.8	16.2	32.4
5,000	2072x1536	1.6	3.2	4.3	6.5	13.0
5,315	2072x1536	1.5	3.0	4.1	6.1	12.2
7,500	1736x1284	1.5	3.1	4.1	6.2	12.3
7,960	1920x1080	1.5	3.1	4.1	6.1	12.2
10,000	1512x1098	1.6	3.1	4.1	6.2	12.4
15,000	1232x888	1.6	3.1	4.2	6.3	12.6
20,000	1064x762	1.6	3.2	4.2	6.4	12.7
30,000	840x624	1.6	3.3	4.4	6.6	13.1
50,000	672x546	1.7	3.4	4.5	6.7	13.4
100,000	672x216	1.8	3.5	4.7	7.1	14.2
200,000	672x96	2.0	4.0	5.3	8.0	16.0
500,000	672x24	3.2	6.4	8.5	12.8	25.6
750,000	448x24	3.2	6.4	8.5	12.8	25.6
1,000,000	336x24	3.2	6.4	8.5	12.8	25.6
2,450,000	280x12	3.1	6.3	8.3	12.5	25.0

Frame rates, resolution, and duration (in seconds). Note: Cameras with frame rates higher than 225,000 are optional. Specifications subject to change.

Specifications

IMAGER

Sensor type	Custom CMOS
Sensor resolution	2072 x 1536 pixel
Sensor size	27.972 mm x 20.736 mm
Sensor diagonal	34.82 mm
Pixel size	13.5 μ m
Bit depth	12 bit (36 bit color)
Light sensitivity Mono (Gain off/on)	16,000 / 125,000
Light sensitivity Color (Gain off/on)	4,000 / 32,000
Standard frame rate	225,000 fps
Optional frame rate	1,000,000 fps*
Maximum frame rate	2,450,000 fps*
Shutter type	Global exposure
Shutter integration time, standard	1 μ s minimum
Shutter integration time, fast mode	168ns* (@ 2.45M fps 277 ns* (@ 1M fps
WDR	Wide Dynamic Range

SYNCHRONIZATION and CAPTURE

Trigger	TTL TO to 0-100%
Trigger modes	Circular, ROC, BROc
Sync	10 Hz - 350 kHz
Luminance histogram	Iris and light assistance
i-CHEQ 360	Camera status LEDs
i-FOCUS	Focusing and depth of field information
i-EXPOSE	High/low exposure highlight
Control	PC or CDUe
IRIG input	IRIG - B to sub 1 μ s
Internal memory	36 GB standard, upgrade to 288 GB

CONNECTIVITY

Video outputs	HD-SDI, HDMI
USB	USB 3
Network	1 Gb RJ45
Video	IXV, AVI (compressed or uncompressed)
Image sequence	TIFF, JPG, RAW
Ethernet control	1 Gb
Remote control	Via supplied software

PC SOFTWARE

Standard control	Control ONE
Premium control	Control Multi-DAQ
Editing	i-SPEED Movie Maker
Analysis	ProAnalyst® by Xcitex
Viewer	i-SPEED Viewer
Software Developers Kit	C++
Synchronized data acquisition	USB DAQ, 8 options
Language	Local language (available in certain countries)

PHYSICAL and ENVIRONMENTAL

Dimensions, inches	14.75 (L) x 5.75 (W) x 6.0 (H)
Dimensions, mm	374 (L) x 143.5 (W) x 150 (H)
Weight	18.7 lb (8.5 kg) with battery
Input voltage	12-36 V
Power consumption	150 W Nominal, 200 W Max
Mounting	1/4 x 20 and 3/8 x 16 tripod plate
Battery	2x 14.4 V 90 Wh
Battery life	1 hour (with both batteries installed)
Lens mount	Custom, swappable lens plate
EMC	EN55032-A, EN55024
Safety	BS EN61010-1 (camera), IEC60950 (PSU)
CE marking	EMC Directive (Camera), EMC Directive, LV Directive (PSU)
Lead free	RoHS Directive
WEEE	Compliant
IP rating	IP 20
Temperature °F	-14 [†] to 122 operation, -4 to 140 storage
Temperature °C	-10 [†] to 50 operation, -20 to 60 storage
Pressure	71 kpa to 106 kpa
Relative humidity	95% at 104°F non-condensing
G-shock	30 G (@ 11 ms IEC 68-2-27 Ea, 30 G (@ 2 ms IEC 68-2-29 Eb
Power input connector	6 pin Lemo
Trigger input	BNC 75 Ω
I/O connector	10 pin Lemo, 12V, Remote Power, IRIG-IN, GPIO 0, 1, GPI 2, Trigger In

PURCHASING OPTIONS

CDUe	Portable Control Unit
Sensor	Color / Mono
Memory	36GB (std) / 72GB / 96GB / 144GB / 192GB / 288GB
Frame speed (option)	1,000,000fps*
Frame speed (maximum)	2,450,000fps*
Shutter integration time	1 μ s (std) / 168ns* (@ 2.45M fps/ 277ns* (@ 1M fps
Internal SSD	500GB / 1TB / 2TB
External SSD	250GB / 500GB / 1TB / 2TB
Lens mounts	F mount (Nikkor D) / F mount (Nikkor D) with shutter / F mount (Nikkor G) / F mount (Nikkor G) with shutter / C mount / EF mount
Warranty	2 yr (std) / 3 yr
Internal Batteries	Set of 2 batteries

*Export restricted.

[†]Cameras must be turned on above 0°C / 32°F and can operate down to -10°C / -14°F.

Our cameras
set us ahead.
Our software
sets us apart.



The i-SPEED® Software Suite 2.0 enables you to use the software with a Windows laptop, desktop, or the optional Controller Display Unit (CDU). With both versions of the PC software—Standard and Premium—you will experience unparalleled features and the most complete set of functions with a modern and intuitive GUI. Control your camera via Gigabit Ethernet connection—load and control single and multiple camera configurations or connect remotely for uninterrupted access to restricted areas.

Two levels to suit your specific application requirements

- Control ONE: Control a single camera from a laptop or PC.
- Control Multi-DAQ: Control multiple cameras and/or synchronize with data acquisition devices.

Local Languages

To accommodate our worldwide customer base, the i-SPEED Software Suite 2.0 will be available in local languages to meet the needs of our global customers.

Video Trigger

The latest feature of the i-SPEED Software Suite 2.0, this functionality allows the user to define trigger levels through a manual mode or choose auto mode and have the software calibrate trigger levels. A real-time track mode has been added for triggering the camera in a dynamically changing environment such as cloud cover.



Record

Customized connection and crowd's-nest layout window

- Instantly sync and record from multiple cameras.
- Choose multiple configurations of a single camera, or quickly configure a new camera and new capture settings from inside the simplified connection control panel.



Edit

Renderless editing suite—i-SPEED Movie Maker features virtually no render lag

- The world's only editing software designed specifically for high-speed video
- Focuses on frame rate and video speed
- Available with Control Multi-DAQ

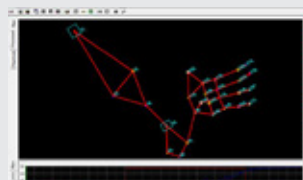

Analyze

Your i-SPEED camera becomes a precision measurement device with ProAnalyst® from Xcitex Inc., the world's most advanced motion analysis software

- Analyze, graph, and output speed, acceleration, fluid dynamics, PIV, and more with optional toolkits.
- Available with Control Multi-DAQ

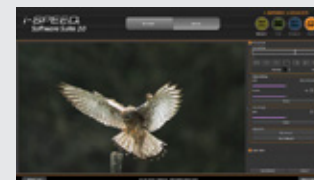

Share

Play just about anything

- View and import saved files directly from the camera.
- Align and play multiple file types.
- Load and control the video and playback speed all without load times—load and play multi-gigabyte files instantly.

Software Developer's Kit (SDK)

iX Cameras will provide the SDK kit and the technical support to customize the software to meet your specific applications needs. We will work with you to integrate program commands into your own software to allow you full control of all i-SPEED 7 camera functions and features.

i-SPEED Software Suite 2.0

	Standard Bundle	Premium Bundle
Bundled Software		
Control ONE	■	
Control Multi-DAQ		■
Viewer	■	■
Movie Maker		■
ProAnalyst® by Xcitex Motion Analysis Software (see next page for details)	Introductory	Lite
Main Functions		
Language	English	Local Languages
Simple Mode	■	■
Customizable Workspaces	■	■
Check for Updates	■	■
Camera Connect		
Single Camera Control	■	■
Multi-Camera Control		■
Sync DAQ Control		■
Camera Naming / Positioning / Appearance	■	■
Crow's Nest Test Set-Up View	■	■
Real-Time Camera Health Monitoring System	■	■
Camera Capture		
i-FOCUS	■	■
i-EXPOSE	■	■
Low Light Mode	■	■
Luminance Histogram (Full Image or ROI)	■	■
Calibration Snapshot for DIC / PIV	■	■
Session Reference / Auto-Black Reference	■	■
Remote Session Reference / Auto-Black reference (with Mechanical Shutter)	■	■
DIC Tools	■	■
Multiple Buffers	■	■
Rearm	■	■
Auto Save		■
Buffer Advance Mode	Auto Advance, Auto Advance and Record	Auto Advance, Auto Advance and Record
Sync Modes	Normal	Normal, Random Snapshot
Sync	Master / Slave	Master / Slave
Trigger Modes	Normal (Circular)	Normal (Circular), ROC, BROCC
Video Trigger		■
Software Trigger	■	■
TTL Trigger	■	■
IRIG Phase Lock (sold separately)	Optional	Optional
i-CHEQ	■	■
Synchronised Integrated Lighting Control*		■
On-Board PIV Double Pulse Timing for Driving PIV Laser Systems		■
Dual Brightness Twin Recording		■
Video Review		
Time Zoom	■	■
Bookmarks	■	■
Measure Window (Angles, Distances)	■	■
Video Processing	■	■
Measure (see next page for details)		
Linear, Distance, and Velocity	■	■
Angular, Angle, and Angular Velocity	■	■
Save		
File Formats	TIFF, JPG, RAW, IXV, AVI	TIFF, JPG, RAW, IXV, AVI
File Name Sequencing for Ingestion Into 3rd Party Software	■	■

*Patent pending

ProAnalyst® Software by Xcitex Motion Analysis Software

ProAnalyst	Introductory	Lite
File Management		
AVI, WMF, ASF, CINE, MPED-1, MOV, and MP4 Files	■	■
BMP, JPG, PNG, TIFF Image Sequence Compatibility	■	■
Project-Based File Management	■	■
Video Explorer	■	■
Pack / Unpack Projects	■	■
Image Calibration and Processing		
Image Processing	■	■
Image Filtering		Limited
Video Timeline	■	■
Layered Display and Editing	■	■
2-D Scene Calibration	■	■
Perspective and Multi-Plane Scene Calibration		■
Video Analysis		
2-D Feature Tracking	■	■
Number of Auto-Track Features	1	256
Number of Manual Track Points	32	256
Real-Time Annotations of Distance and Angle Between Features		■
Graphing and Computation		
Graphing Within ProAnalyst		Limited
Notes and Reports		
External Data Import		■
Tracking Data Export to C3D, Diadem, Excel, MATLAB	Limited	■
Video Frame, Data Point, and Global Notes		■
Image Annotation	■	■

ProAnalyst Professional and 3-D Professional	Professional	3-D Professional
Image Calibration and Processing		
3-D Manager		■
3-D Scene Calibration		■
Lens Distortion Correction	■	■
Video Analysis		
Image Stabilization Toolkit*	Optional	Optional
Particle Counting, Sizing, and Tracking Toolkit*	Optional	Optional
Contour / Edge Analysis Toolkit*	Optional	Optional
Particle Image Velocimetry Toolkit	Optional	Optional
Impact Excursion Toolkit	Optional	Optional
Biological Cell Tracking Toolkit	Optional	Optional
1-D Line Tracking	■	■
3-D Measurement and Analysis		■
Graphing and Computation		
One-Click FFT	■	■
2-Axis Graphing	■	■
3-Axis Graphing	■	■
3-D Graphing of Trajectories from 3-D Manager	■	
Data Filtering	■	■
Notes and Reports		
HTML, PowerPoint, and Print-Ready Report Generator	■	■

*Included in Professional Ultimate Bundle

Upgrade Options

- From **Introductory** to **Professional** Edition
- From **Introductory** to **Professional Ultimate Bundle**
- From **Lite** to **Professional** Edition
- From **Lite** to **Professional Ultimate Bundle**
- From **Professional** to **3-D Professional** Edition
- From **Professional Ultimate Bundle** to **3-D Professional Ultimate Bundle**

iX Cameras shares its CAD models

With many applications, the camera is a component in the overall solution. While commercially available accessories can fulfill most requirements, there are always some situations that require a bit extra. This may be as simple as a bracket to mount an accessory to the camera, or as complex as a full OEM system integration. Whatever the requirement, accurate and complete interface data is a must. As such, iX Cameras is pleased to provide another first in our industry by opening access to the CAD model data for the exterior of our cameras.

For more information, please visit our [Cameras CAD Models](#) page.

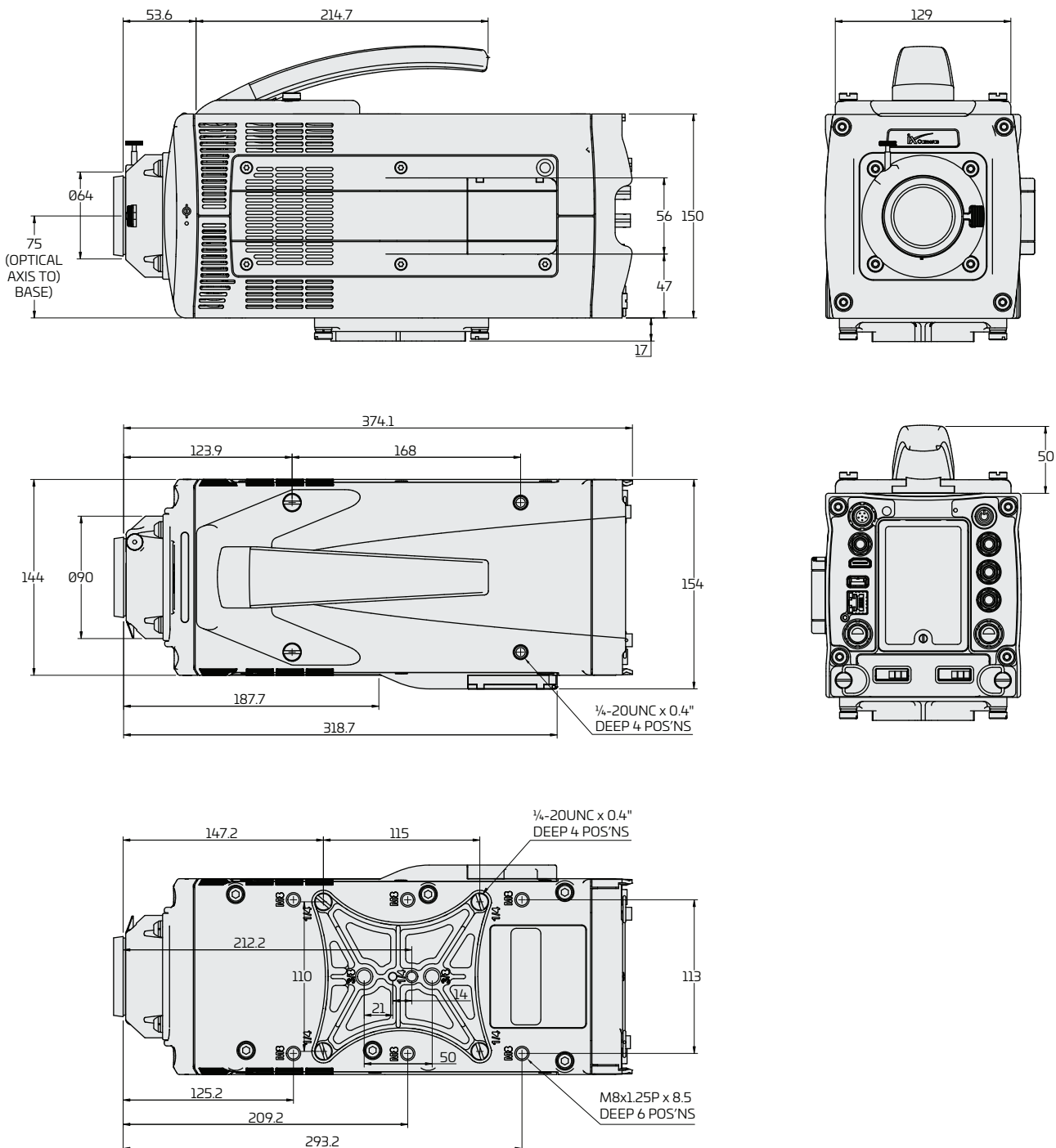

Advanced high-speed cameras for any application

The new i-SPEED® 7 Series with the AST sensor offers our customers three models (717, 721, 727) of high-speed cameras to use in the lab, field, or test range recording a wide range of applications without compromising high resolution at high recording speeds—capturing the fastest events while reducing motion blur.

Fluid Dynamics

The combination of high resolution and integrated lighting control allows for perfect capture of fluids with zero motion blur.

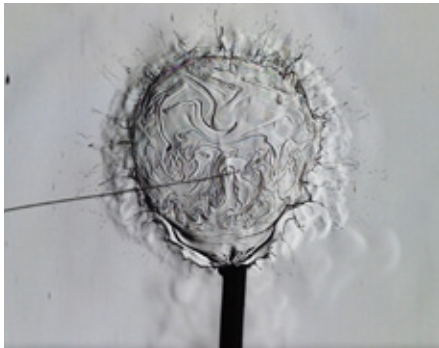

Courtesy: Linden Gledhill

Ballistics

With the highest pixel throughput available (27.1Gp/s), the 7 Series provides industry leading resolution values at high frame rates.



Digital Image Correlation (DIC)

The 7 Series cameras use the new AST high-resolution sensor, enabling small particle correlation with zero interpolation.

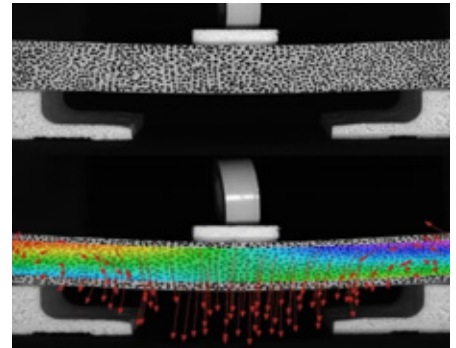

Motion Analysis

When accuracy of motion analysis is paramount, the high resolution, high dynamic range allows for perfect 2D and 3D analysis.

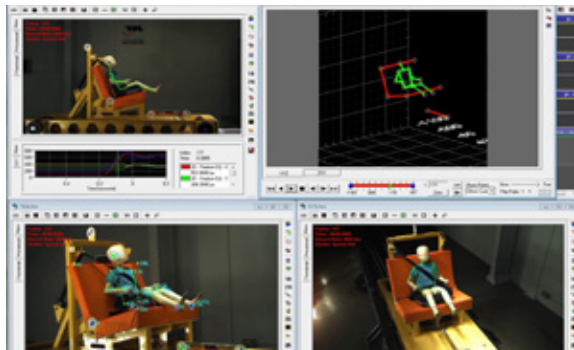

PIV

Large area medium pixel sensors are ideal for PIV applications, giving high resolutions as well as high sensitivity.

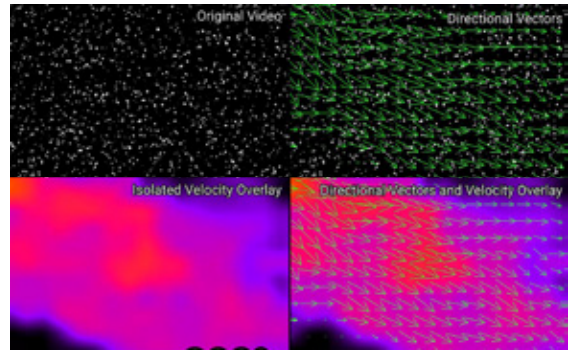

Scientific Research

The wealth of functions and features that the 7 Series offers enables the most extreme tests to be completed with ease.

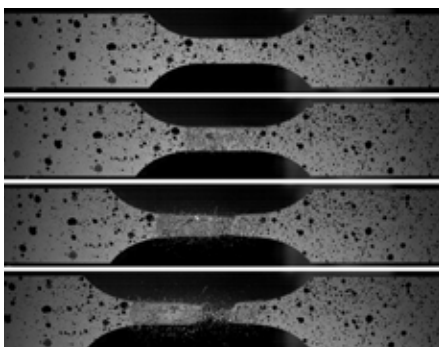

Fragmentation

When the environment is tough the camera also needs to be tough. The new 7 Series provides a tough 30G case made from a solid billet of aluminum.



Schlieren

Traditional mirror and modern digital techniques both excel with the AST Sensor due to its high sensitivity and resolution.

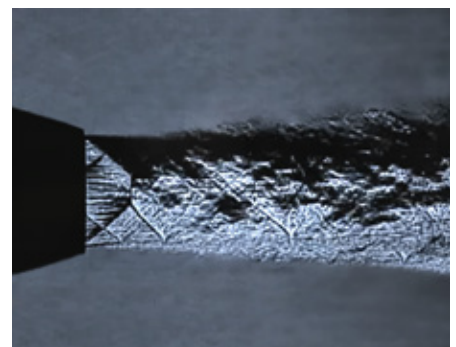

Courtesy: Dr. Charles Tinney, Applied Research Laboratories, University of Texas at Austin and Dr. Nathan Murra, University of Mississippi

A legacy built on innovation

iX Cameras is a world-leading technology and product company specializing in the field of high-speed (slow motion) imaging. Based on proprietary innovative technologies, we design, build and sell cutting-edge, ultra-fast cameras and software for a wide range of advanced scientific research applications. The innovation of our i-SPEED® brand of cameras is backed by our world-class service and support teams, ensuring our customers' success.

iX Cameras was created in 2014 when we purchased the Olympus product group that has been developing and selling the i-SPEED brand of high-speed cameras for over a decade. Today, the same heralded development team from Olympus, combined with new camera and software industry veterans, continues to design innovative state-of-the-art i-SPEED cameras under the iX Cameras brand. Our commitment is simple—innovate and push the boundaries of high-speed video science, developing technically superior and easy-to-use products that allow customers to attain the highest scientific achievements and creativity.



iX Camera support and service locations

iX Cameras is dedicated to providing the best support and customer communication possible. Use the information below to get comprehensive company-wide contact information for any question or topic which you may have.

United Kingdom

Bradley House
Locks Hill
Rochford Essex, SS4 1BB
T: +44 (0) 1702 540 669

United States

8 Cabot Road
Suite 1800
Woburn, MA 01801
T: +1 339 645 0778

China

Room 605, Building 8
No 365, Chuanhong Road
Pudong New District
Shanghai, 201323
T: +86 186 215 60553

India

C-207, Twin Arcs
Legacy Life Spaces, Punwale Bazar
Punawale, Pune-411033
Maharashtra
T: +91 955 256 5021

info@ix-cameras.com

ix-cameras.com

To find the iX Cameras sales partner nearest you, visit our [Worldwide Distribution](#) page.